

Fitting Instructions

Description:	OCAM Deluxe Bull Bar, Heavy Duty Steel, Winch Compatible, ADR Compliant
Model:	For Mazda BT-50, 2011-07/2020
Item NO.:	BB2-BT50-16

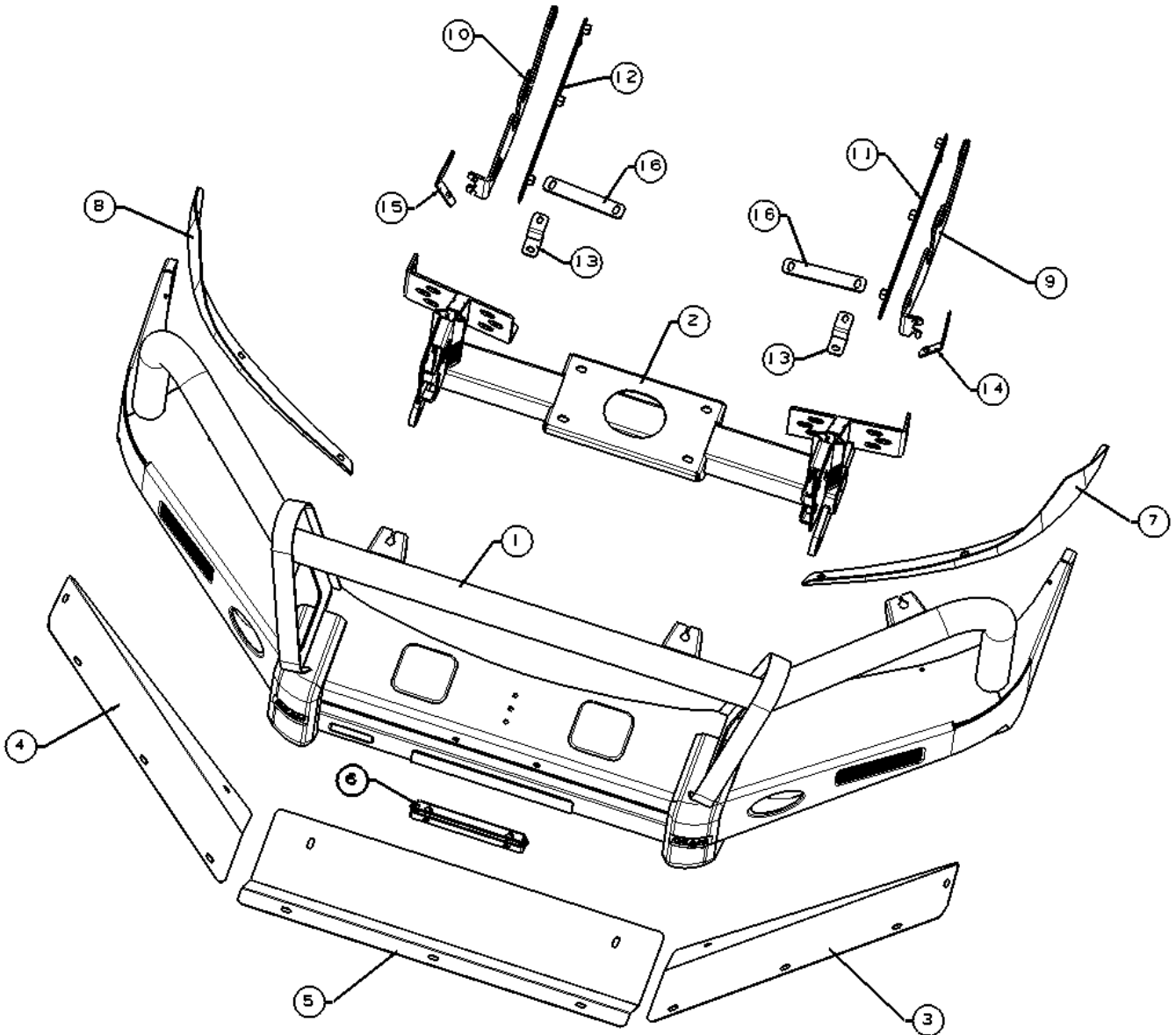

Note:





- 1) This bull bar is only suitable for the vehicle make/model/series stated above.
- 2) Do not remove the compliance label.
- 3) Do not change the structure of the bull bar.

Fitting Instructions

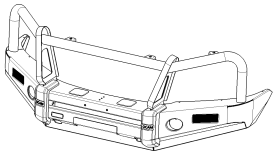
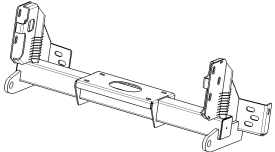
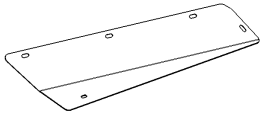
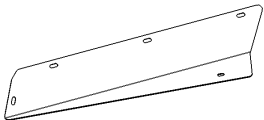
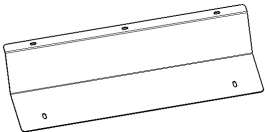

Standard locking torque

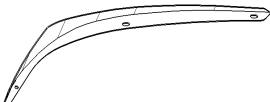
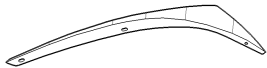
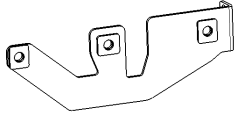
M6 - 11Nm | M8 - 18Nm | M10 - 80 Nm | M12 - 90 Nm | M16 - 90 Nm

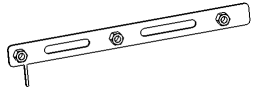
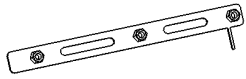
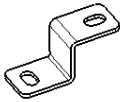
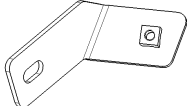
Bom list

Item	Item NO.	Description	Qty	Item	Item NO.	Description	Qty
1	200306440	 Bull bar assemble	1	2	200306239	 Winch Frame	1
3	200306579	 Bash Plate (LH)	1	4	200306580	 Bash Plate (RH)	1
5	200306578	 Center Bash Plate	1	6	E280008049	 Number Plate Hinge Bracket	1
7	200306629	 Eyebrow (LH)	1	8	200306630	 Eyebrow (RH)	1
9	200306739	 Chassis Mount (LH)	1	10	200306740	 Chassis Mount (RH)	1
11	200075135	 Chassis Mount bracket (LH)	1	12	200075137	 Chassis Mount bracket (RH)	1
13	200306624	 Bash Plate Joint A	2	14	200327886	 Bash Plate Joint B LH	1

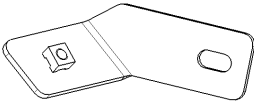
Fitting Instructions

15	200327987		1	16	200307024		2
		Bash Plate Joint B RH				Mud Fender Bracket	
17	200120188		1				
		Pinch Weld (2000mm)					

Bolt Kit

Item	Item NO.	Description	Qty
18	3000147	Spring Washer M8	4
19	3000160	Spring Washer M10	8
20	3000171	Spring Washer M12	12
21	3000245	Flat Washer M10(10x30x2.5mm)	12
22	3000415	Flat Washer M8(8x28x3mm)	4
23	3001491	Hex Nut M10	4
24	3001505	Hex Nut M12	6
25	3001577	Flange nut M8	4
26	3002617	Hex Bolt M8_40	4
27	3002720	Hex Bolt M10_40	8
28	3002822	Hex Bolt M12_40	6
29	3003088	Hex Bolt M12x1.25_40	6
30	3004967	Flat Washer D12_32_3	18

Eyebrow Bolt Kit

31	3000062	Allen Wrench S=4	1
32	3000228	Flat Washer D6(6x18x1.6mm)	6
33	3000740	Dome Head Bolt M6x25	2
34	3001569	Flange nut M6	14
35	3006267	Combo M6x20 Dome Head Bolt x Spring Washer x Flat Washer	8
36	3006351	Combo M6x20 Dome Head Bolt x Spring Washer Flat Washer (OD 18mm)	17

Fitting Instructions

1. Installation Steps:

Remove front surround



Remove & discard all plastics in front and below beam.
Remove and discard front intrusion beam and fasteners



Fitting Instructions

2. Chassis Mount: item 9&10&11&12/ 20&29&30

Use below bolt kits:

1. item 20/29/30: :

Hex Bolt M12x1.25x40 + Spring washer M12 + Flat Washer M12x32x3

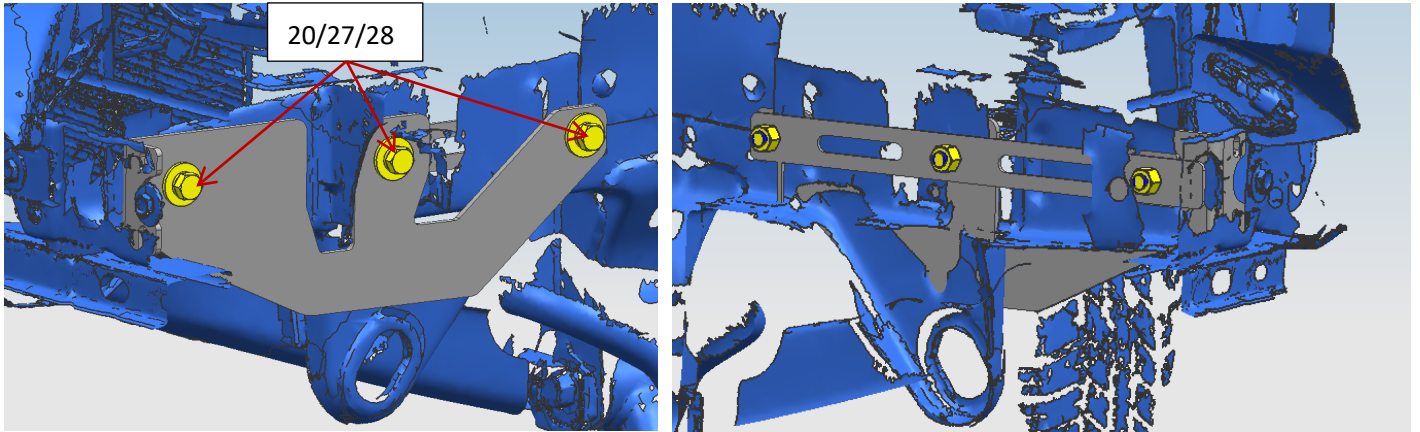
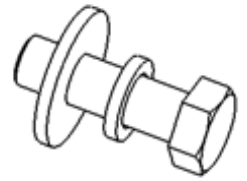

3. Winch frame - item 2

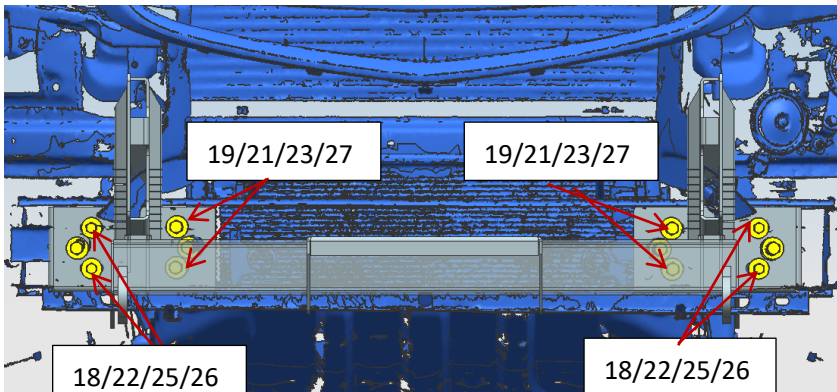

1.item 18/22/25/26

Hex Bolt M8_40 + Flat Washer M8 (8x28x3mm) + Flange Nut M8 + Spring Washer M8

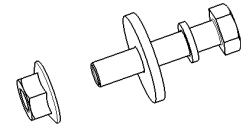

2.item 19/21/27

Hex Bolt M10x40 + Spring Washer M10 + Flat Washer M10 (10x30x2.5mm)

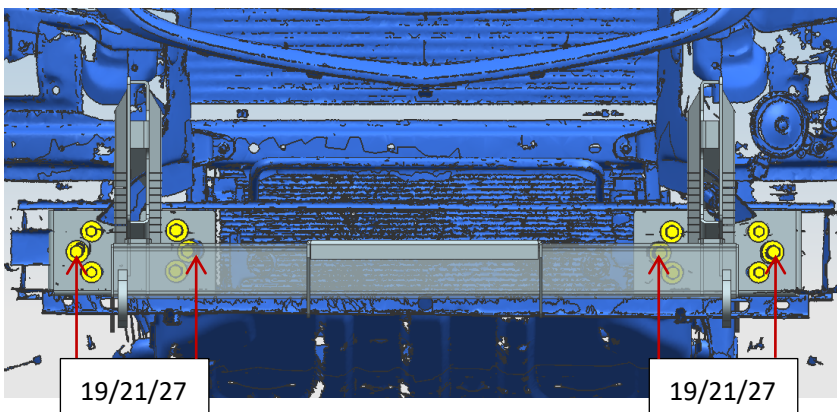
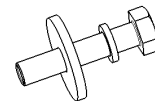

3. item 19/21/23/27

Hex Bolt M10x40 + Spring Washer M10 + Flat washer M10 (10x30x2.5mm) + Hex Nut M10

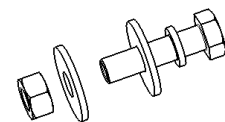

Fitting Instructions

4. install item 7 & 8

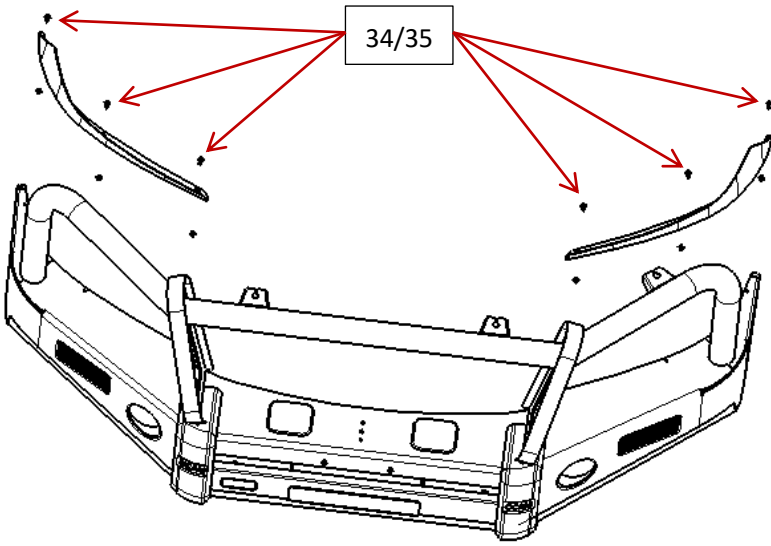

Use below bolt kits:

1. item 34/35:

Combo M6x20 Doom head bolt x Spring washer x Flat washer + M6 flange nut

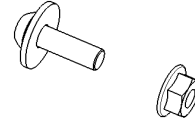

5. install item 1

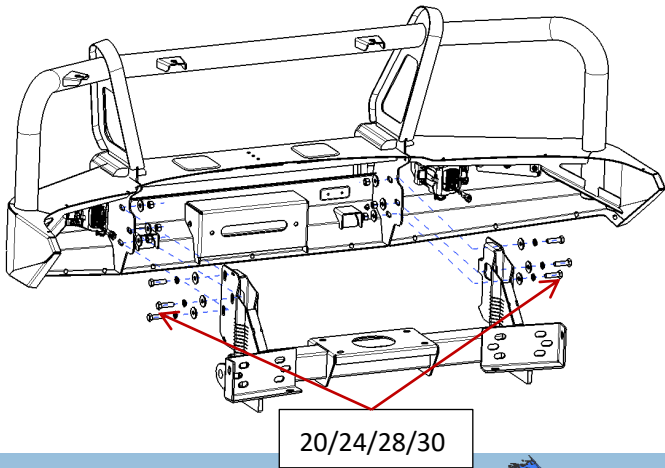

Use below bolt kits

1. item 20/24/28/30

Hex bolt M12x40+ Spring Washer M12 + Flat Washer M12x32x3 + Hex Bolt M12

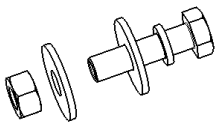

Fitting Instructions

6. install item 13&14&15&16

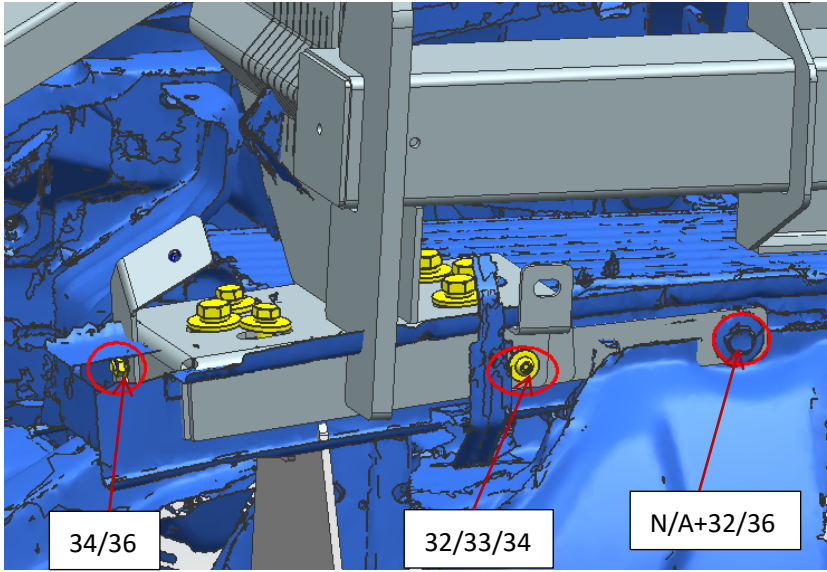

Use below bolt kits:

1.Item 16:

Original Bolt + Flange Nut M6 + Flat Washer M6(6x18x1.6mm)



2.Item 13&16:

Dome head bolt M6x25 + M6 Flange Nut + Flat Washer M6(6x18x1.6mm)



3.item 14&15:

Combo M6x20 Doom head bolt x Spring washer x Flat washer combo + M6 flange nut

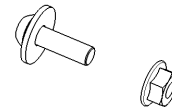

7.install item 3&4&5

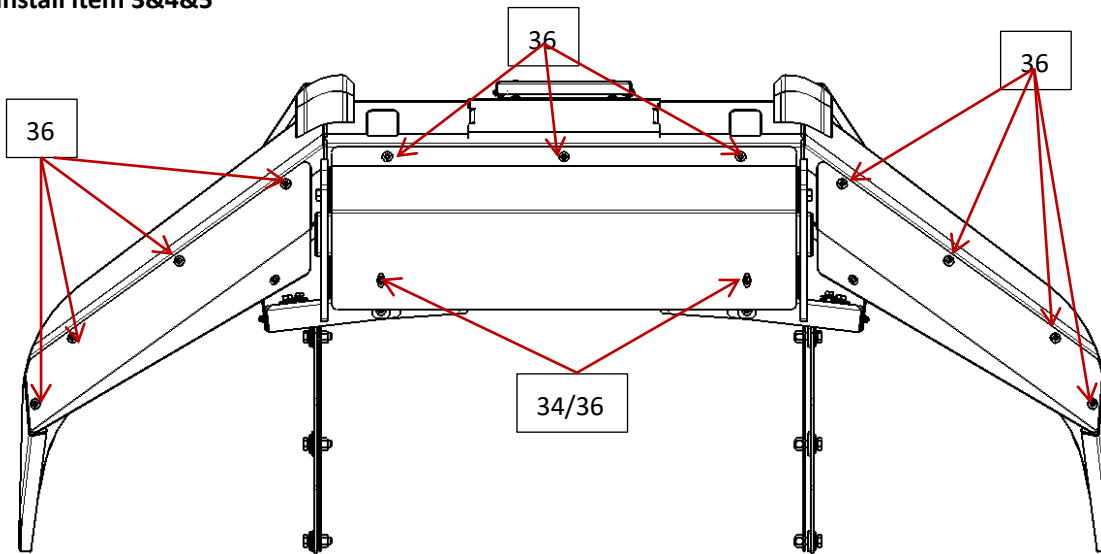

Use below bolt kits:

1. Item 36:

Combo M6x20 Doom head bolt x Spring washer x Flat washer



2. item 34/36:

Combo M6x20 Doom head bolt x Spring washer x Flat washer + M6 flange nut

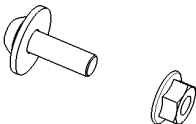

Fitting Instructions

8.install item 6:

Using Package set M6x20 Doom head bolt x Spring washer x Flat washer

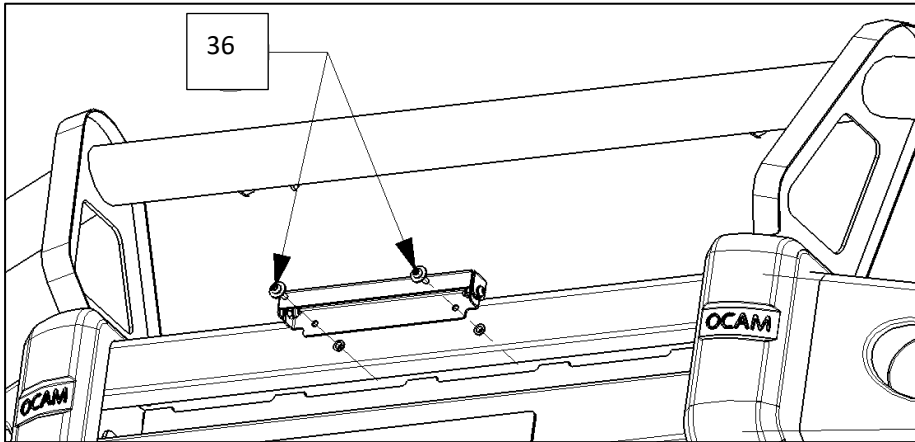

9. Item 13 the L brace is for fastening the grill with original fasteners

10. Test and make sure that the guard is steadily fixed, fully tighten all hardware

11. Installation is finished, pick up all tools.
