

Fitting Instructions

Description :	OCAM Heavy Duty Steel Side Steps
Model :	Toyota Hilux 2015-20 Dual Cab
Item NO. :	SS2-REVO

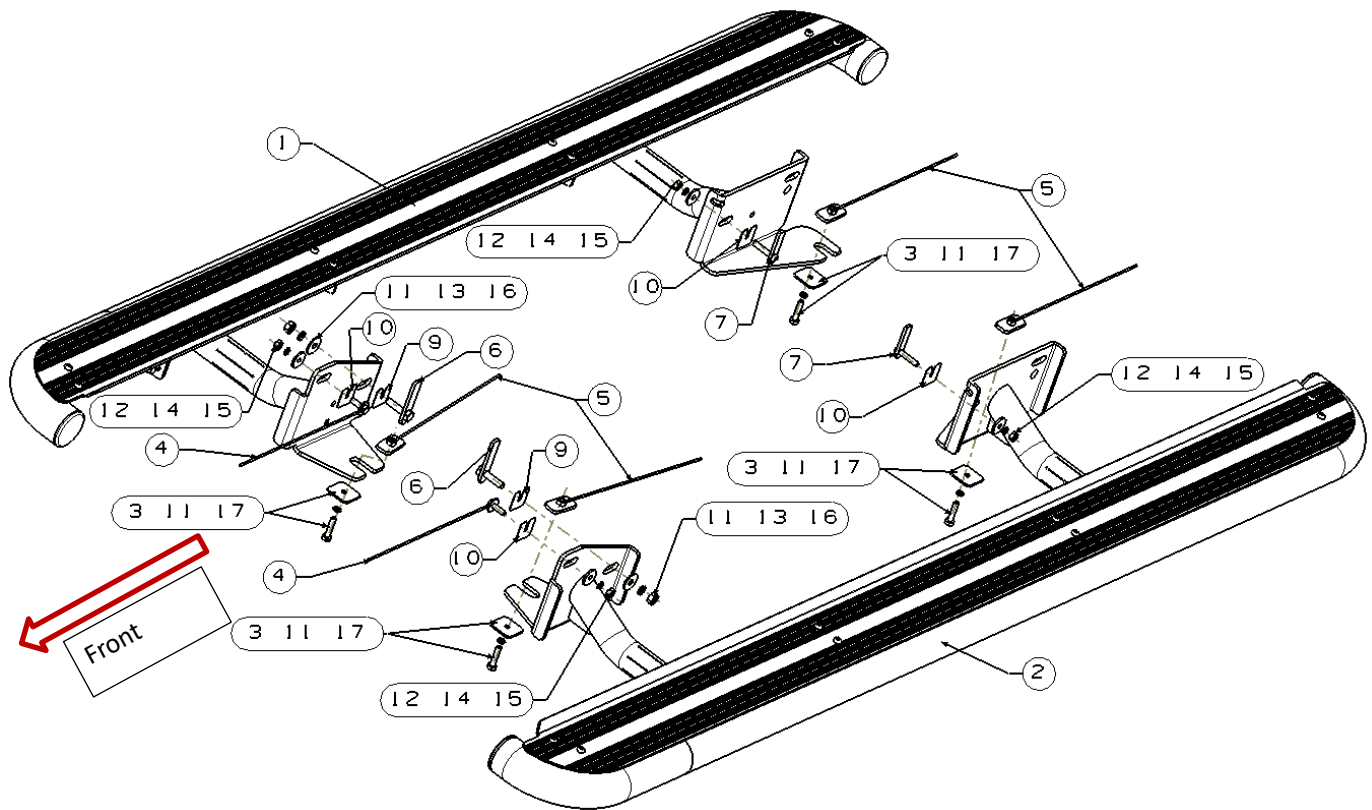

Before Installation

- Please read the instruction carefully. They will also help you to avoid scratches or other potential damage to your vehicle.
- All images are for reference only and may vary slightly with the actual product you've received.

Care and Cleaning







- Mild soap may be used also to clean the side steps.
- Please periodically check and retighten all the hardware and keep your investment clean for a fresh look.

Fitting Instructions

Standard locking torque

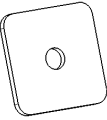
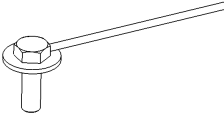
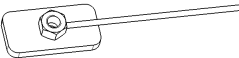
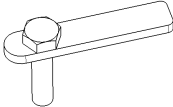
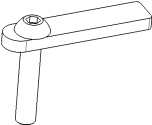
M10 - 80 Nm

Parts list

Item	Item NO.	Description	Qty	Item	Item NO.	Description	Qty
o1	200305741	 Main step LHS	1	o2	200305860	 Main step RHS	1
o3	E200056360	 Spacer	4	o4	E200244876	 Bolt on wire M8x25	2
o5	E200244880	 Nut on plate M8	4	o6	TY001178	 T-bolt M10x40	2
o7	TY001542	 T-bolt M8x40	2	o8	200109093	 Zip tape	2
o9	200193009	 M10 plastic clip	2	o10	200193010	 M8 plastic clip	4

Hardware kit

Item	Item NO.	Description	Qty
o11	3000147	Spring Washer D8	8
o12	3000160	Spring Washer D10	2
o13	3000245	Flat Washer M10(10x30x2.5mm)	2
o14	3000415	Flat Washer M8(8x28x3mm)	4
o15	3001481	Hex Nut M8	4
o16	3001491	Hex Nut M10	2
o17	3002609	Hex head bolt M8x35	4

Fitting Instruction

Fitting Instructions

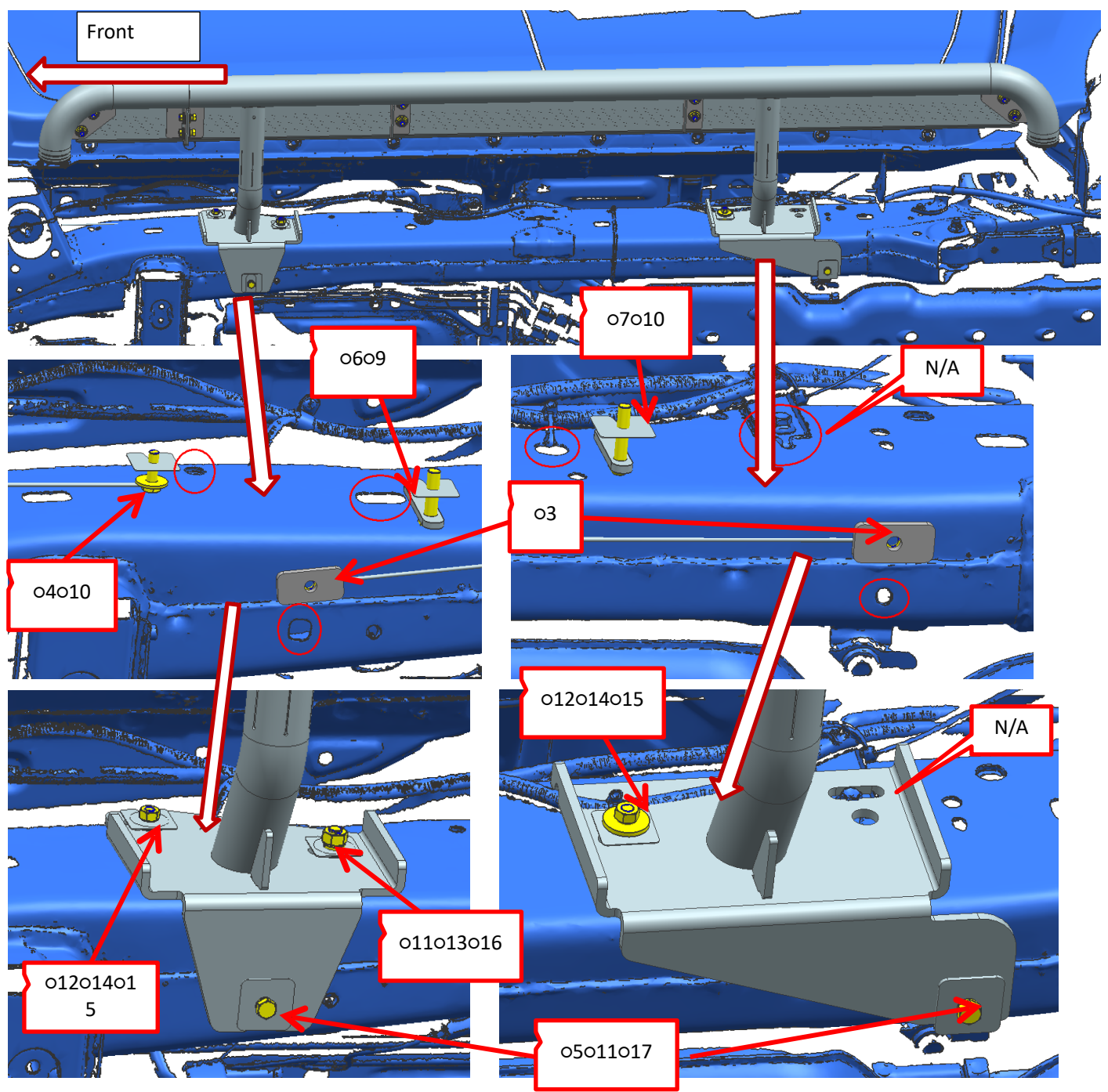

1. Please remove the original bolts (marked N/A) from chassis (please keep them aside)& remove the zip tapes on the chassis
2. Install o3o4o6o7 to the positions as indicated above and use the plastic clip o9o10 to hold the fasteners in place
3. Install the side steps on the fasteners and install o5o11o12o13o14o15o16o17 to above indicated positions.
4. Put the original bolts (marked N/A) back to their position and use Zip tapes o8 to secure the original wiring looms.
5. Adjust the steps to the suitable position and then fasten all the fasteners.